

PRODUCT DESCRIPTION

- Combines several functions:
 - lighting fixture
 - frame for a stretched ceiling
 - frame for a suspended ceiling made of plasterboard, etc.
- The extrusion has a channel adapted to attach standard harpoons used in stretched surfaces.
- The FOLED system opens new possibilities of interior design

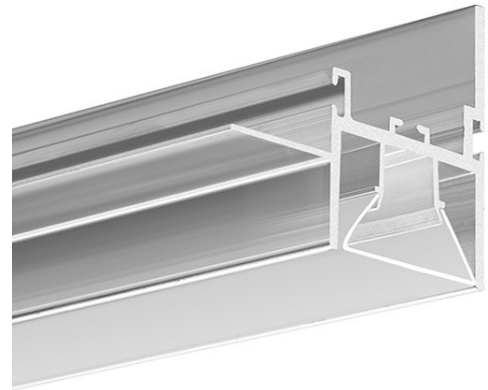

Product nr.	
Fixture type	
Company	
Job name	
Date	

TECHNICAL SPECIFICATION

B8334V1NA_1	Non anodized (raw)	1000 mm
B8334V1NA_2	Non anodized (raw)	2000 mm
B8334V1NA_3	Non anodized (raw)	3000 mm

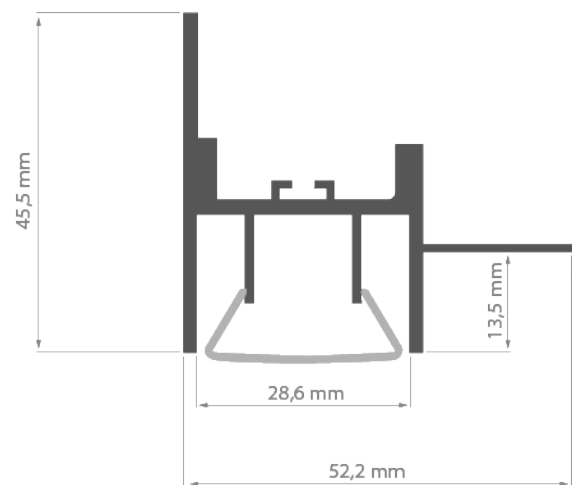

RELATED PROFILES

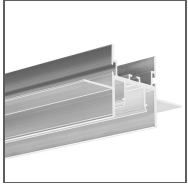

Ref: B8332V1NA

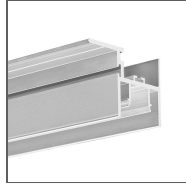

Ref: B8333V1NA

RELATED PRODUCTS

COVERS

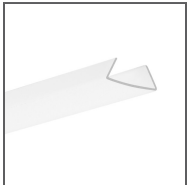

Ref: 17077V1

80°



FITTINGS - connection methods for profiles

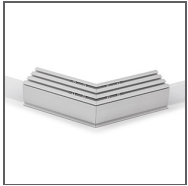

L135

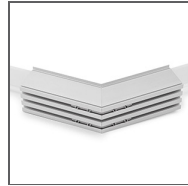

L135PW

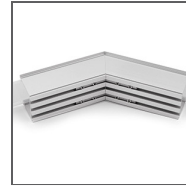

L135PZ

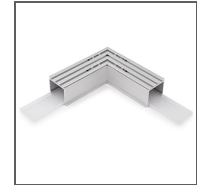

L90



L90PW

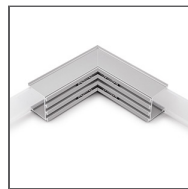

L90PZ

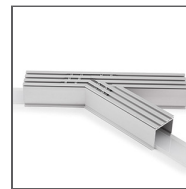

T135L

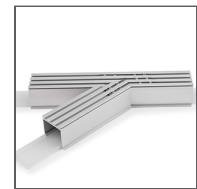

T135R

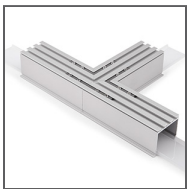

T90

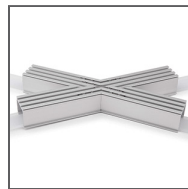

X135

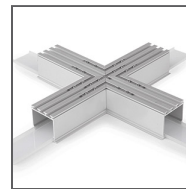

X90