

PRODUCT DESCRIPTION

- Ability to create a line of light
- Concealed aluminum components
- Can be mounted in 16mm thick drywall



Product nr.	
Fixture type	
Company	
Job name	
Date	

TECHNICAL SPECIFICATION

B7823NA_1	Non anodized (raw)	1000 mm
B7823NA_2	Non anodized (raw)	2000 mm
B7823NA_3	Non anodized (raw)	3000 mm

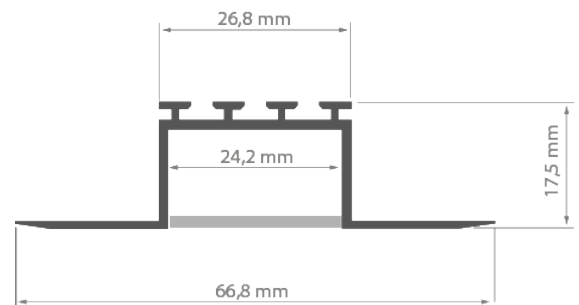

RELATED PRODUCTS

COVERS

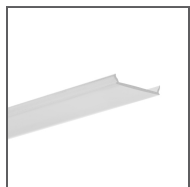

Ref: 17042

90°

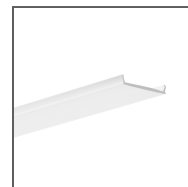

Ref: 17032V1

90°

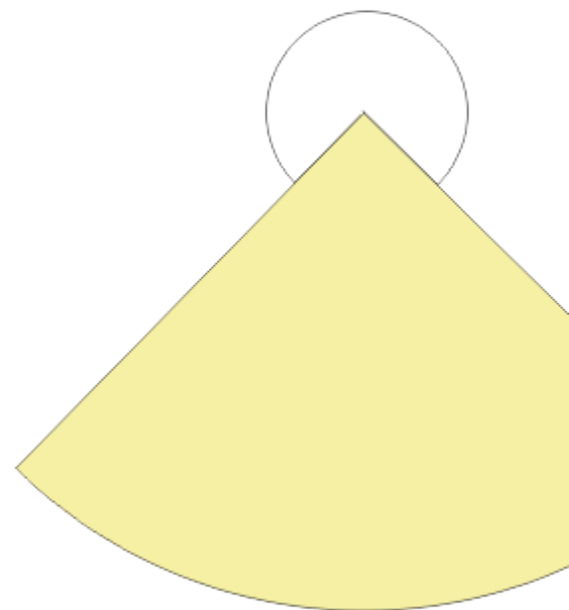
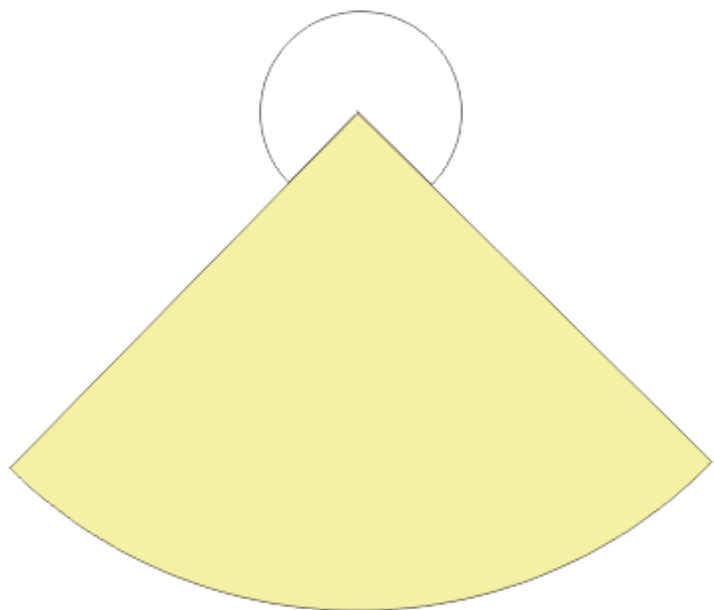

END CAPS

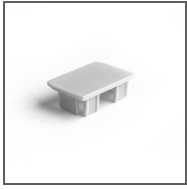

Ref: 24148

ACCESSORIES



Ref: 42717

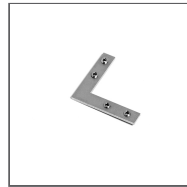

Ref: 42716

FITTINGS - connection methods for profiles

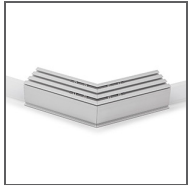

L135

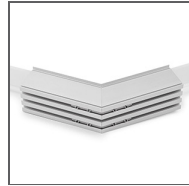

L135PW

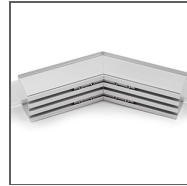

L135PZ

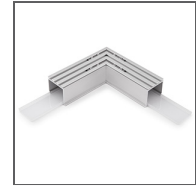

L90



L90PW

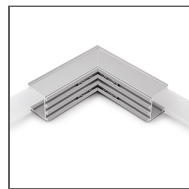

L90PZ

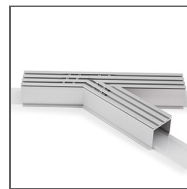

T135L

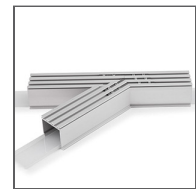

T135R

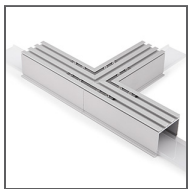

T90

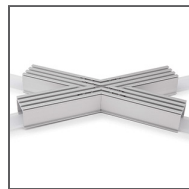

X135

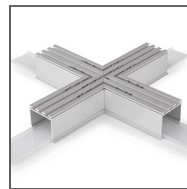

X90