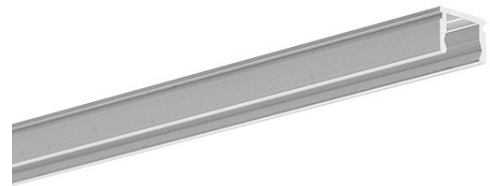

PRODUCT DESCRIPTION

- Minimum width and length
- Narrow line of light

Product nr.	
Fixture type	
Company	
Job name	
Date	

**TECHNICAL SPECIFICATION**

B8288ANODA_1	Silver anodized	1000 mm
B8288ANODA_2	Silver anodized	2000 mm
B8288ANODA_3	Silver anodized	3000 mm

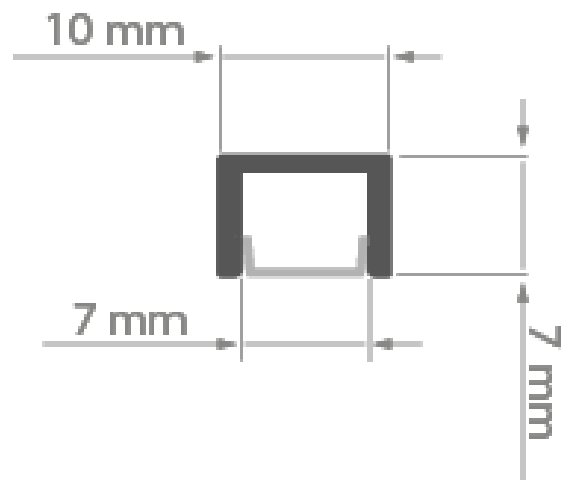

RELATED PRODUCTS

COVERS



Ref: 17034



END CAPS

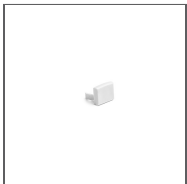

Ref: 24202

FITTINGS - connection methods for profiles

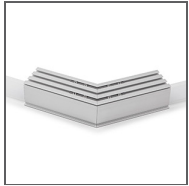

L135

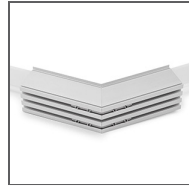

L135PW

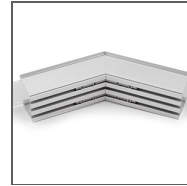

L135PZ

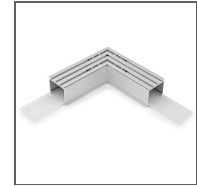

L90



L90PW

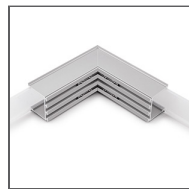

L90PZ

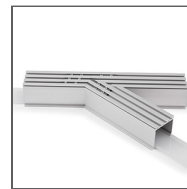

T135L

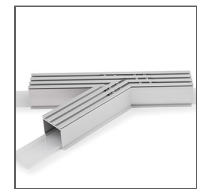

T135R

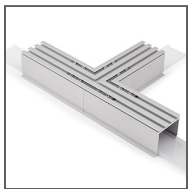

T90

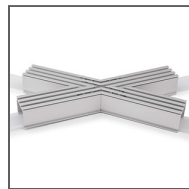

X135

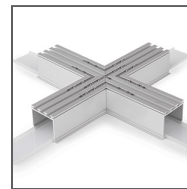

X90