

# Specification

DLS1.0-LS2013(B)

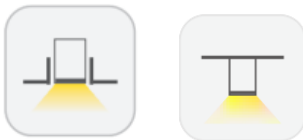

## LS2013(B)



### Features

DLS1.0, a special local auxiliary lighting system, can be widely used in various interior decoration scenarios and local light spaces. A touch of auxiliary decorative lighting in addition to the basic lighting creates different atmospheres and visual enjoyment.

Embellish life with light that follows you whenever you go.

1、 “Dots-free”lighting

Perfect homogenous lighting.

2、 Various diffuser options

Several options of diffusers, In various shapes and light distribution plans Complete with everything needed

3、 “Two” end caps

Two options of end cap for two ways of wire outgoing, Close-fitting design without screws makes installation much easier

4、 Various installation methods

A wide range of installation accessories wider applications

5、 “One” cut

Consistent length between diffuser and profile

6、 Smart control for unlimited possibilities

Perfectly match the profiles like customized, Control by hand sweep or touching

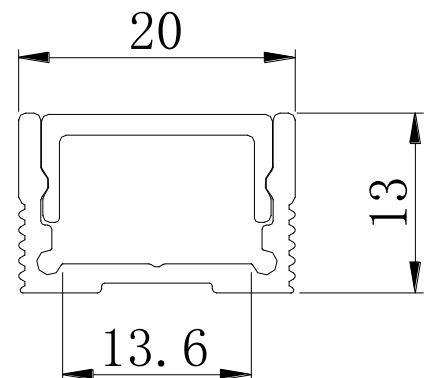

## Details

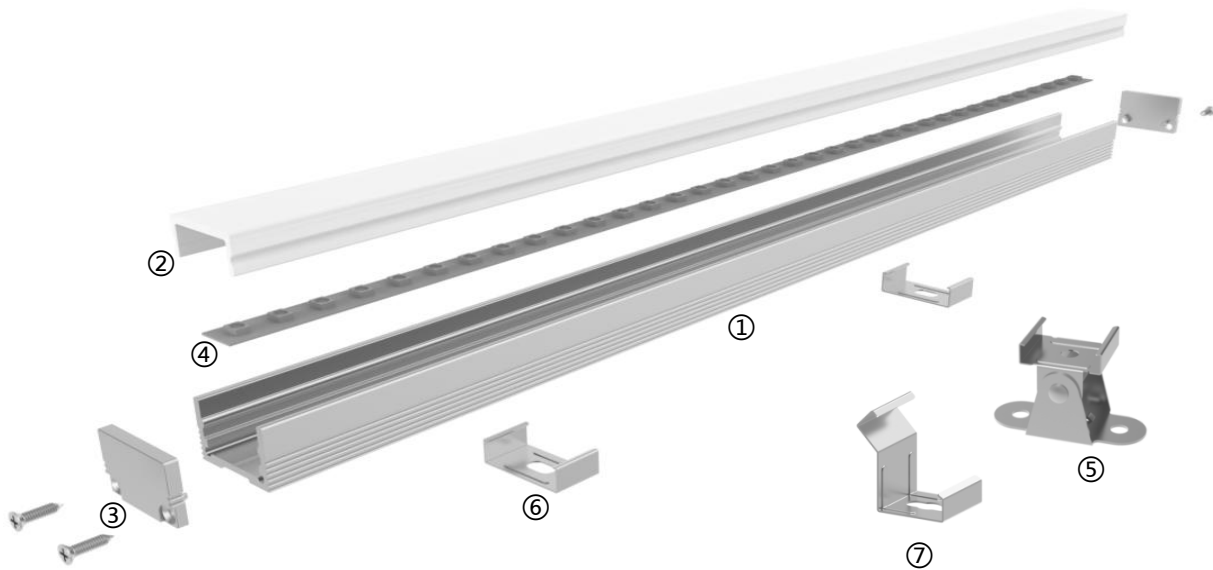

## Standard Configuration

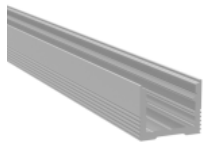

### ①Profile:

Installation: Surface mounted/Recessed  
 Material: AL6063-T5  
 Applications: Indoors  
 Profile weight: 0.473kg/2.5m  
 Size: L2500\*W20\*H13mm  
 Surface processing: Anodizing



### ②Diffuser:

Type: Frosted diffuse  
 Material: PC  
 Light transmittance : 60%  
 Size : L2500\*W16.7\*H7.8mm  
 (shrink) 0.8mm/m when the temperature rises (drops) 10°C.

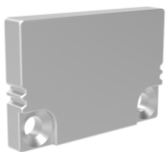

### ③End cap:



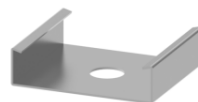



Material : fireproof PC  
 Size : L20\*W13\*H4.5mm  
 Surface Technic : Spray paint



### ⑥Clips:

Material : SUS304  
 Size : L21.8\*W12\*H6.4mm

**Optional Accessories**

Reference Photo	Name/Model	Size (mm)	Material
	End cap with hole	L20*W13*H4.5mm	fireproof PC
	⑦Clip for 45 degree fixation	L20.2*W12*H19.85mm	SUS304
	⑤Adjustable clips	L35*W17.7*H22.8mm	SUS304
	④FPC strip D6280L-24V-10mm	Material : FPC , CCT : 2700/3000/4000/5000/6000K ; Ra > 90; Voltage:24V ; Power : 8W/m ; Lumen : 850Lm/m ; PCB width : 10mm ; Minimum cut : 50mm ;	
	④FPC strip D6280H-24V-10mm	Material : FPC , CCT : 2700/3000/4000/5000/6000K ; Ra > 90; Voltage:24V ; Power : 15W/m ; Lumen : 1600Lm/m ; PCB width : 10mm ; Minimum cut : 50mm ;	
	Power	Three-in-one dimming power driver ( 0-10V、PWM、resistance ) ; size : 363*34.5*22.5mm; white; 65W	

### Optical Parameter

D6280H-24V-10mm driver, frosted diffuser

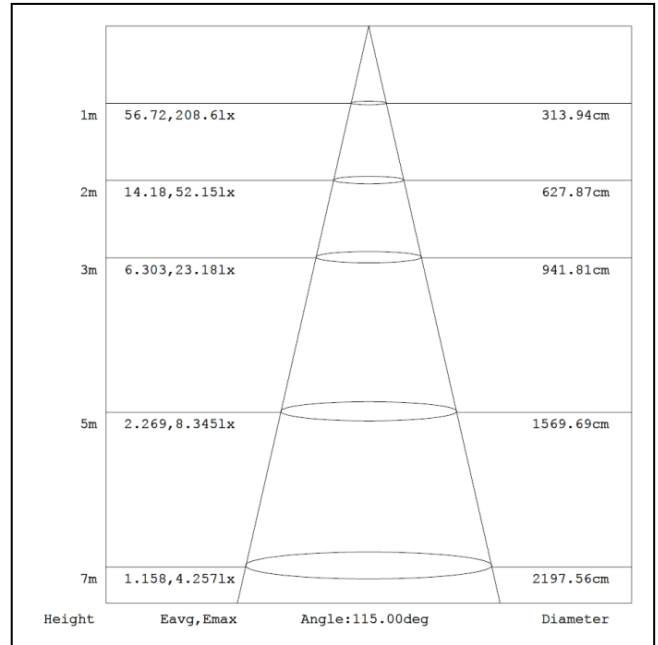
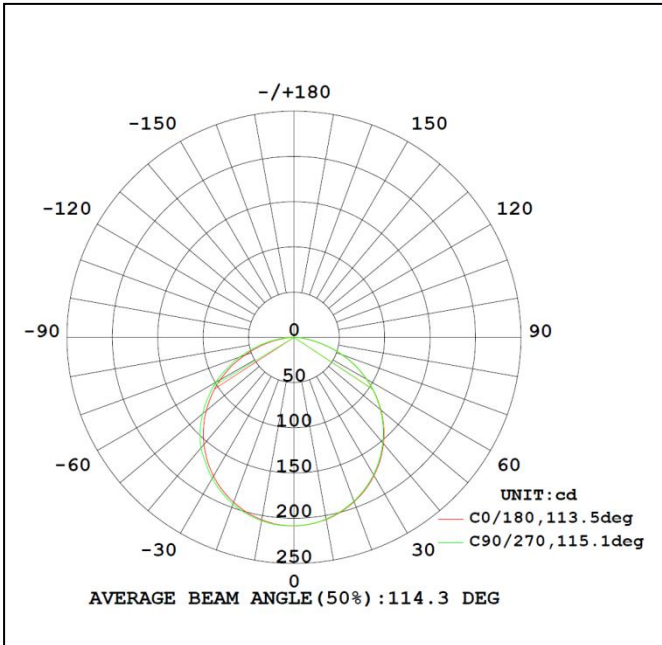

## Package

### 1. Component Packaging

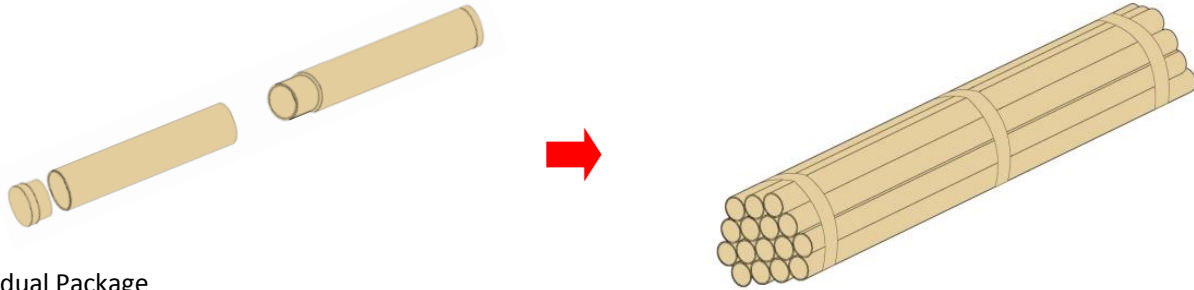

Individual Package

Type	Size(mm)	NW(kg)	GW(kg)	Content
Circular cylinder	Φ31*2580	0.65	1.1	1set ( Profile+Diffuser+Endcap+Clips )

Bundle

CBM(m <sup>3</sup> )	Size(mm)	NW(kg)	GW(kg)	Qty/bundle
0.05	155*124*2580	10.4	17.6	16 set

### 2. Raw Material Packaging

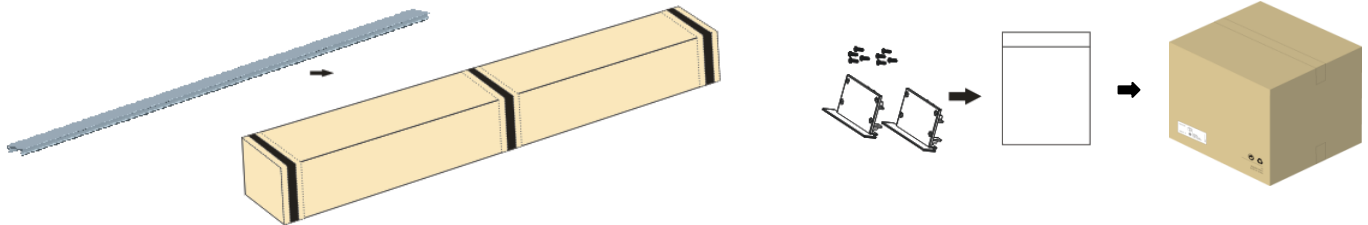

Profile Package

Type	Size(mm)	NW(kg)	GW(kg)	Content
Packing box	2564*118*99	18.92	21.2	40Pcs

Diffuser Package

Type	Size(mm)	NW(kg)	GW(kg)	Content
Packing box	2564*118*99	9.6	11.9	80Pcs

End capPackage













Type	Size(mm)	NW(kg)	GW(kg)	Content
packing carton				200Set ( 2Pcs/Set )

clipsPackage

Type	Size(mm)	NW(kg)	GW(kg)	Content
packing carton				100Set ( 4Pcs/Set )

### Ways to sell :

Standard product + flexible customization

Profile (component packaging)								
Standard product	Item	Profile	Diffuser	End cap	clips			
	PIC							
	Amount	1 pcs	1 pcs	4 pcs	8 pcs			
Options	Customizable length: $\leq 2.5m$ , customizable label: by COLORS/customer Customizable profile color: silver, black, white							
Accessory 1 (raw material packaging)								
Standard product	Item	Profile	Diffuser	End cap	clips	Adjustable clips	Clip for 45 degree fixation	FPC strip
	PIC							
	Amount	1 pcs	1 pcs	2Pcs/Set	100Set ( 4Pcs/Set ) /box	50Set ( 4Pcs/Set ) /box	100Set ( 4Pcs/Set ) /box	5 m/reel
Accessory 2 (raw material packaging)								
Standard product	Item	Power	End cap with hole					
	PIC							
	Amount	1 pcs	2Pcs/Set					
Standard luminaire (finished luminaries)								
Standard product	Item	2.5m luminaire						
	Amount	1 pcs						
Options	* Customizable length $\leq 2.5m$ * Customizable profile color: silver, black, white * Please take the cutting unit into consideration when you need to customize the luminaire size * Optional label: by COLORS/customer							

